



NRG70 Stable DOOR

70mm PVCu Stable Door



OPTIONAL



Chamfered bead

OPTIONAL



Sculptured bead

Platinum
NRG

www.platinumnrg.co.uk

OR

Platinum[®]
NRG

NRG70 Stable DOOR

HARDWARE OPTIONS

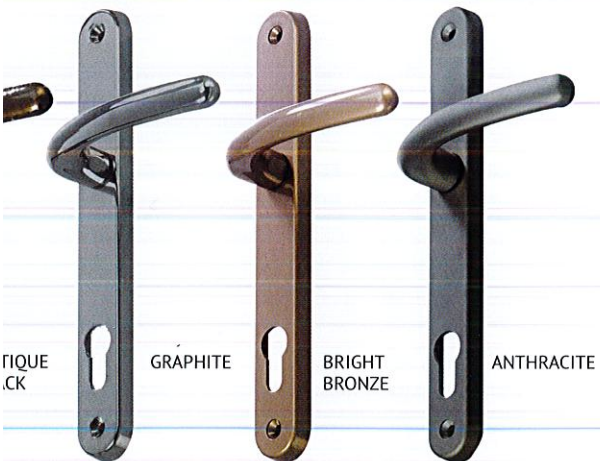

Pad combinations available.



Sculptured



Oak

Black

Cream

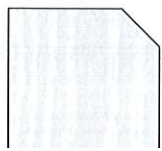

HINGES

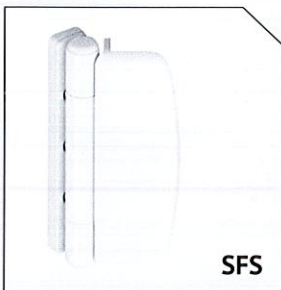

Choice of hinges ensure ease-of-use and a draft-free fit and use stainless steel stabilising pins for enhanced security. Available in a choice of colours to match your door.

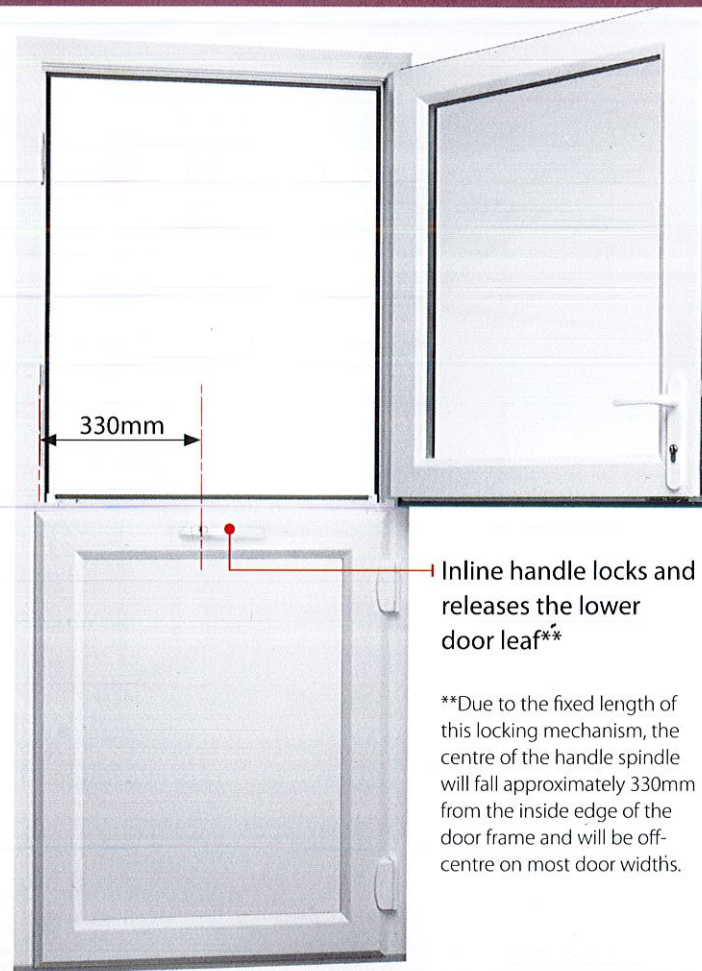

**Due to the fixed length of this locking mechanism, the centre of the handle spindle will fall approximately 330mm from the inside edge of the door frame and will be off-centre on most door widths.



NRG70 Stable DOOR

THIS EXAMPLE SHOWS THE **CHAMFERED FRAME** IN AN **INWARD-OPENING** CONFIGURATION

100% LEAD FREE PVCu
Completely free of poisonous lead stabilisers.

GLOSS FINISH
Polished finish reduces cleaning and maintenance and retains a cleaner look for longer helping resist airborne pollutants and moulds.

DOUBLE-GLAZED UNIT
available for entire door or by using additional transoms and mullions just for parts of the door.

SOLID REINFORCED PANELS available for entire door or by using additional transoms and mullions just for parts of the door.

Weather bar

LOW PVCu threshold

Stub cill

THRESHOLD OPTIONS

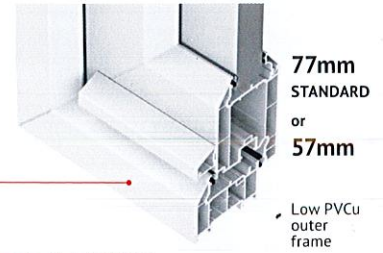

FRAME ONLY

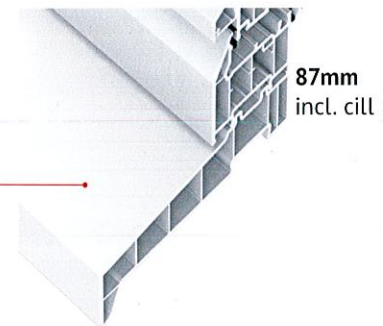

FRAME AND CILL

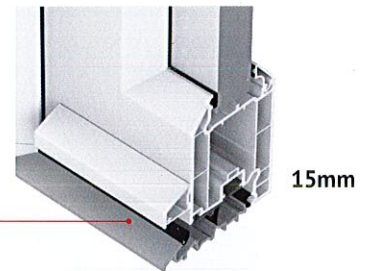

ALUMINIUM PART M COMPLIANT

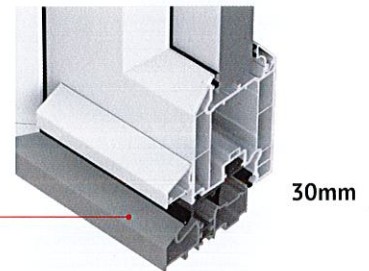

ALUMINIUM LOW THRESHOLD

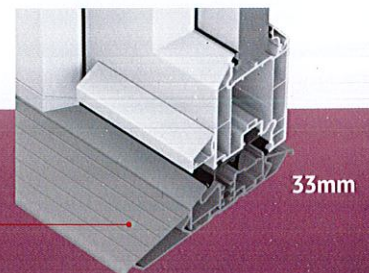

ALUMINIUM LOW THRESHOLD AND TRAY RAMP

